

Technical Data Sheet

CODE 11933

NICOTRA Gebhardt AT 10/8

Centrifugal Fans AT belt driven

NICOTRA | Gebhardt



Nicotra Gebhardt S.p.A. (Italy)
Nicotra Gebhardt GmbH (Germany)

TECHNICAL AND PERFORMANCE DATA

Permissible Nominal Motor Power	kW	3
Permissible Fan Speed	rpm	2500
Permissible Bearing Load	N	350
Permissible Media Temperature	°C	-20/+85
Maximum Delivery Airflow	m ³ /h	6600
Maximum Delivery Pressure	Pa	1790
Fan Weight	kg	8.3

İletişim Bilgileri:

Adres: İkitelli OSB Marmara Sanayi Sitesi C Blok Sk.C blok No:4 P.K :34307 Küçükçekmece / İstanbul

Telefon : (+90) 212 901 00 77

Email: info@avensair.com satis@avensair.com

Technical Data Sheet

CODE 11933

NICOTRA Gebhardt AT 10/8

Centrifugal Fans AT belt driven



Dimensions in mm, subject to change.
AT S-10/8 8.3 kg

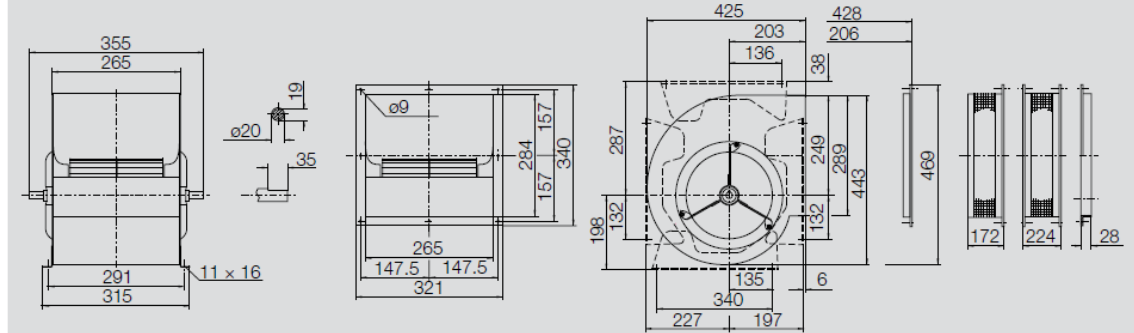

Performance Curves

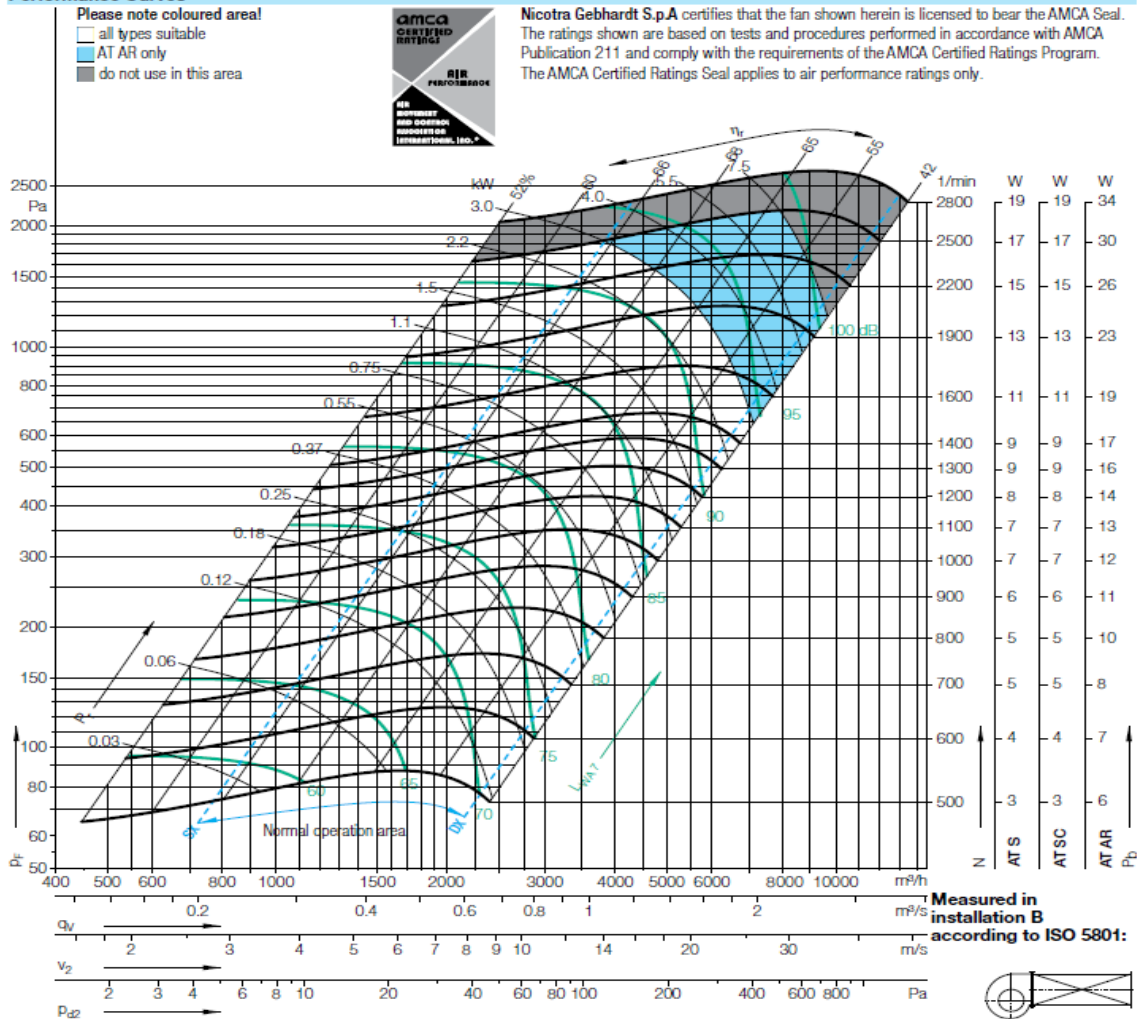

İletişim Bilgileri:

Adres: İkitelli OSB Marmara Sanayi Sitesi C Blok Sk.C blok No:4 P.K :34307 Küçükçekmece / İstanbul

Telefon : (+90) 212 901 00 77

Email: info@avensair.com satis@avensair.com